

All dimensions based on stackup of sheetmetal, subject to variation of 1/2" (13 mm)

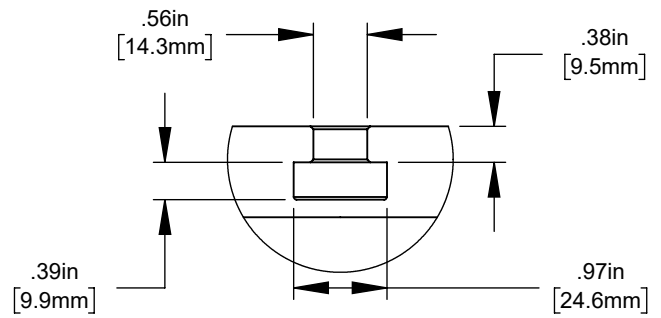
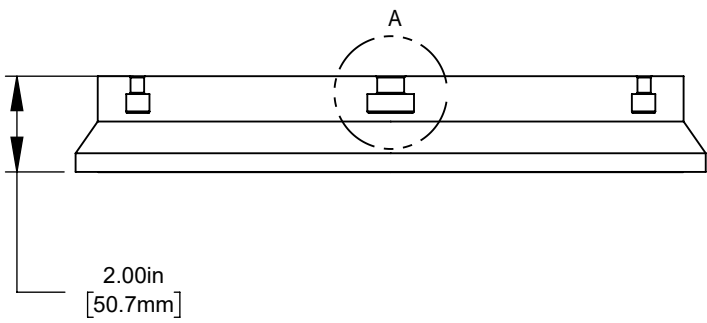
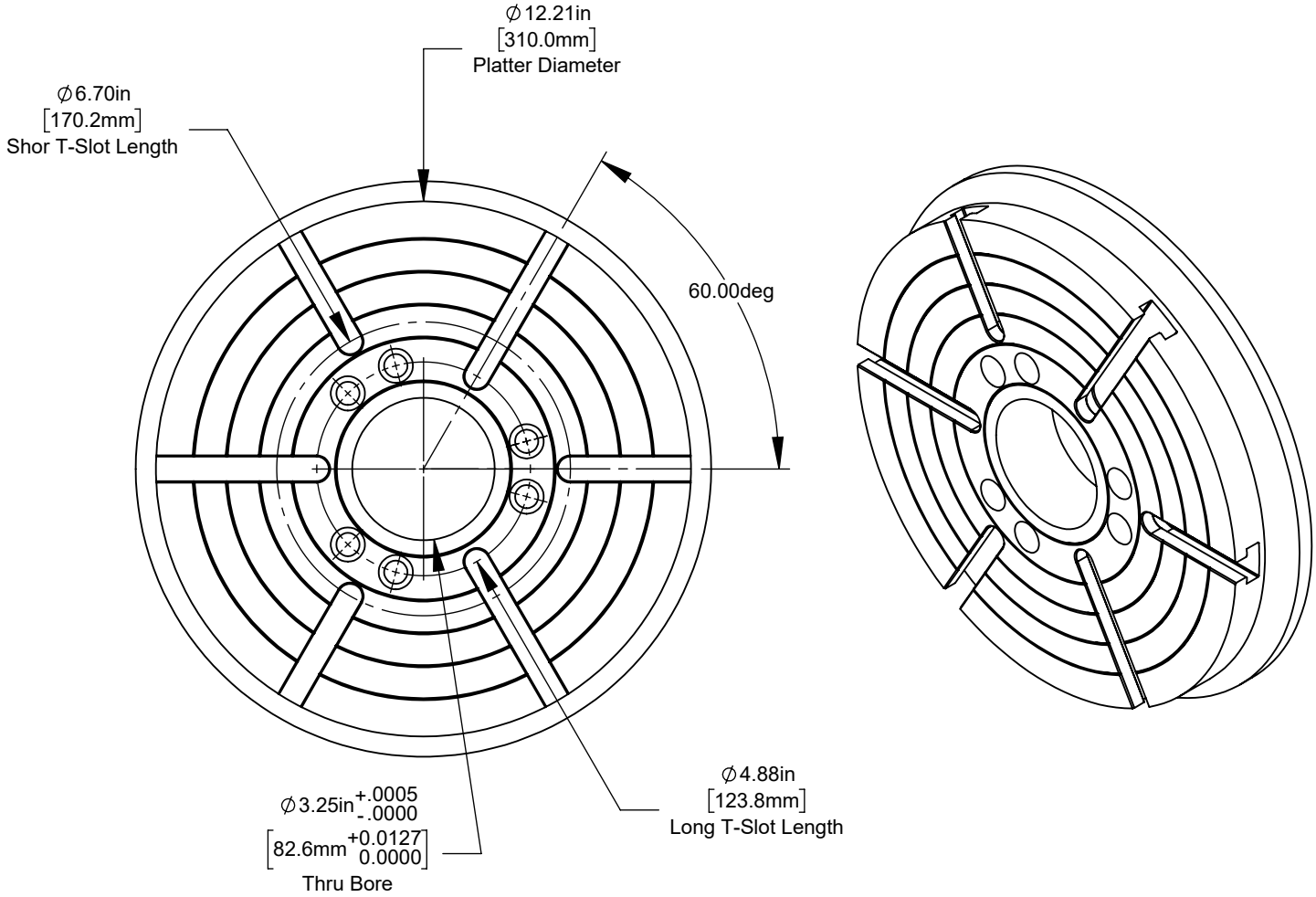

DETAIL A
SCALE 1 : 2